





Bourryto's

Advent
Calendar



2023



printable

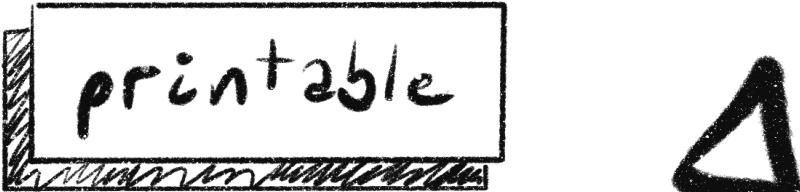

Intro

Welcome to my 2023
advent calendar!

Over 24 Days we will
build paper figures that
we assemble into a
mobile or, if you can't
or don't want to hang one,
a garland.

Every time you've assembled
a part, you can add it by
threading the string through
the figure.

Setup Instructions

1. Tape 2 skewers together (2x)

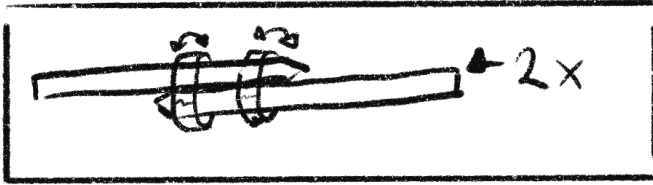

2. Bind Both into a cross

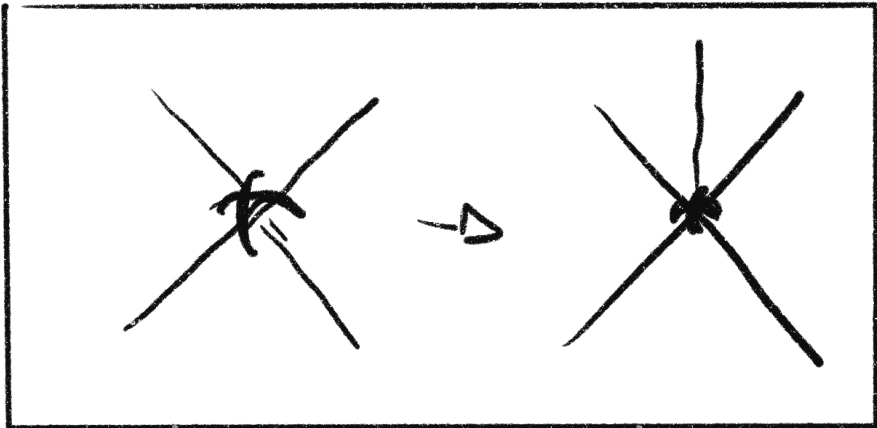

3. Bind ~30cm strings on all 4 ends and the middle

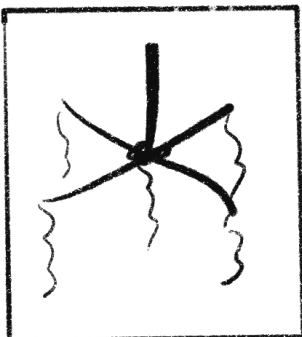

Day 1: Earth

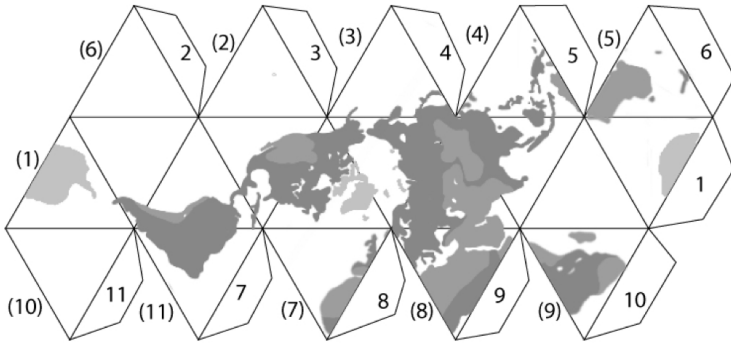

colour suggestion:

- Blue + green + yellow

Day 2: Stars

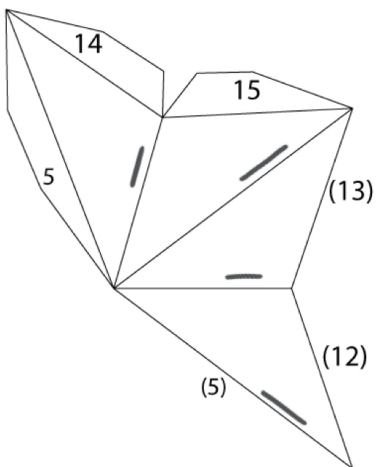
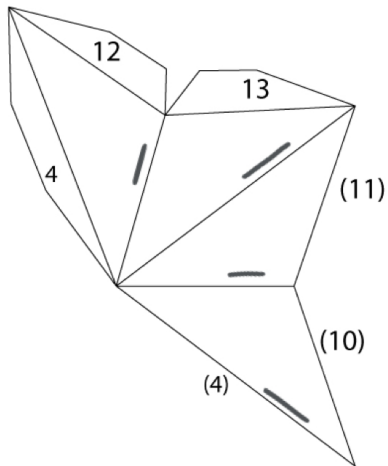
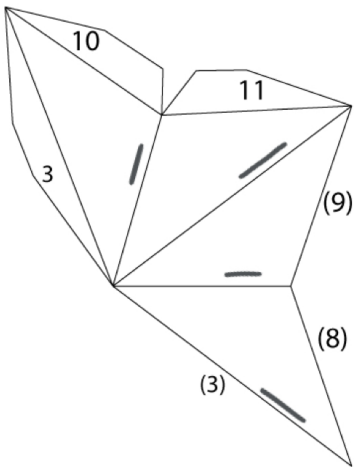
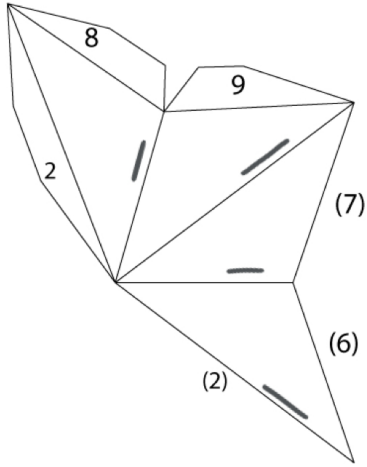
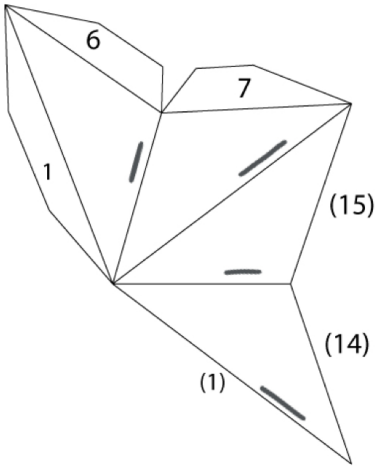

Colour
Suggestion:
yellow

Day 3:
neptun

color:
blue

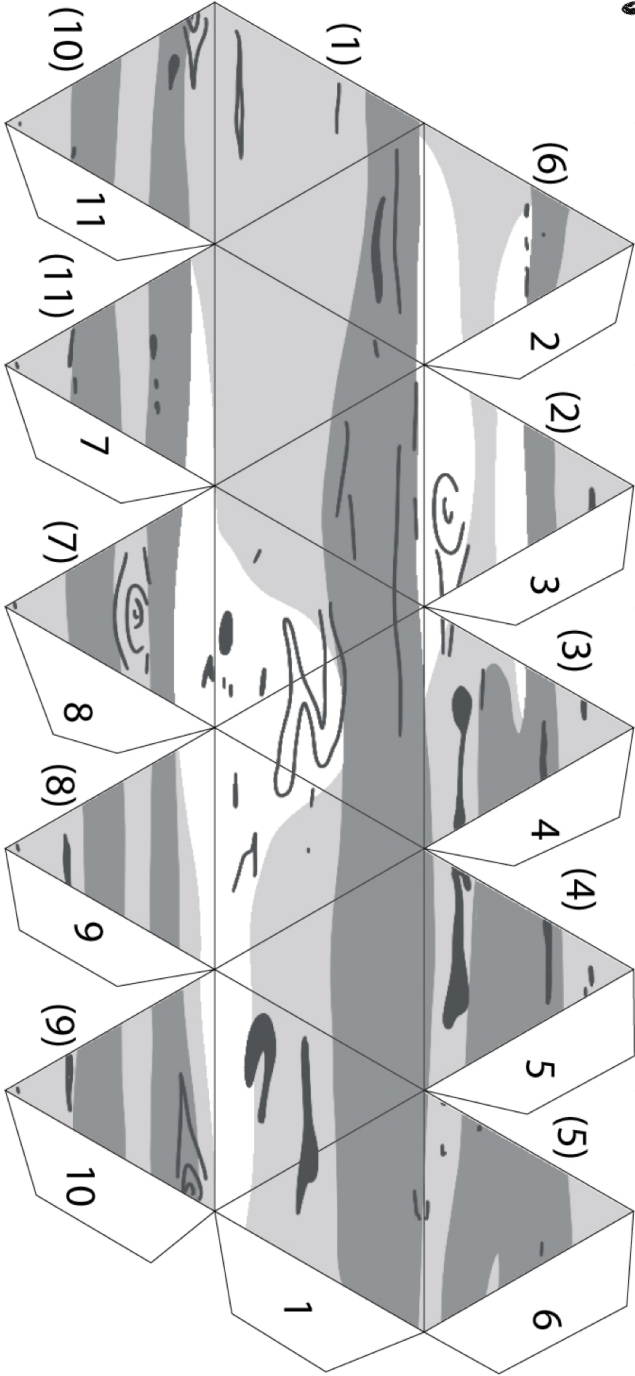

Day 4

asteroid
Fire

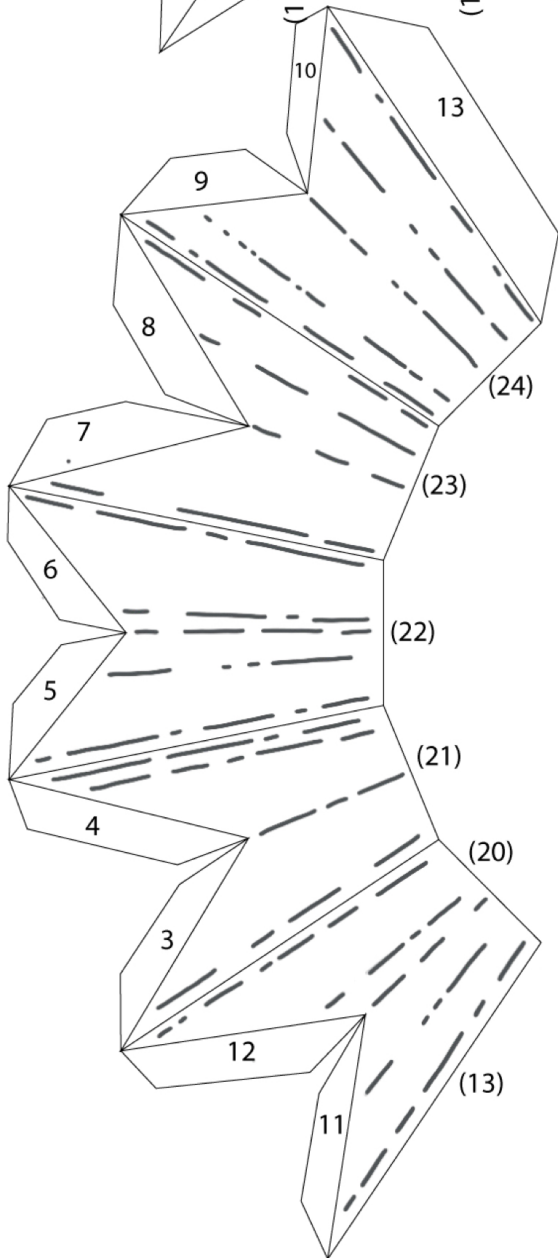
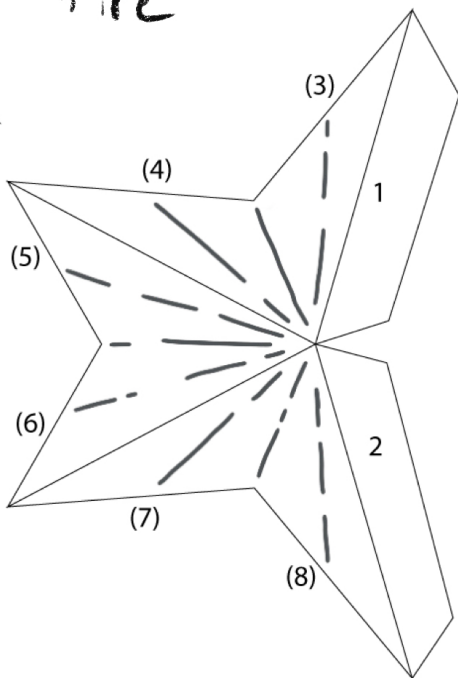
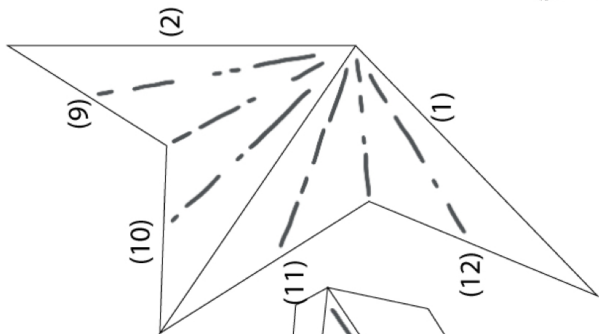

color :
red ,
orange ,
yellow

Day 5

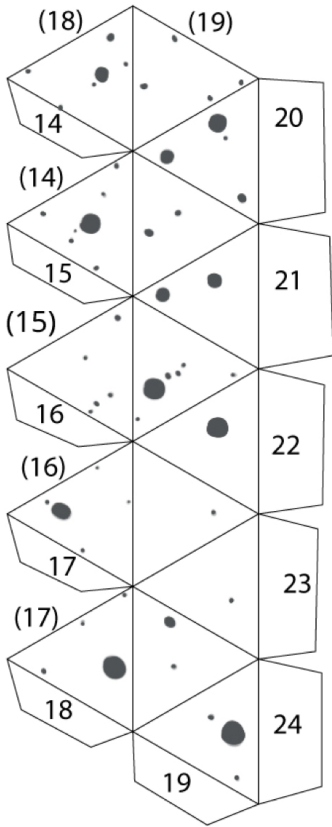

asteroid
body

color:
grey

Day 7: Stars

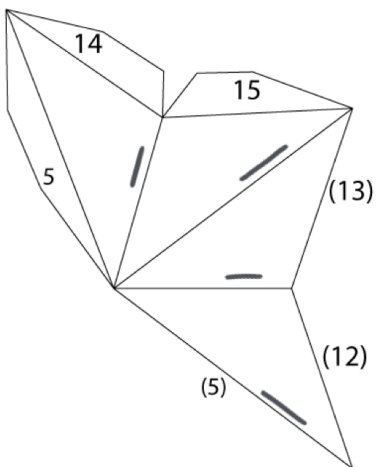
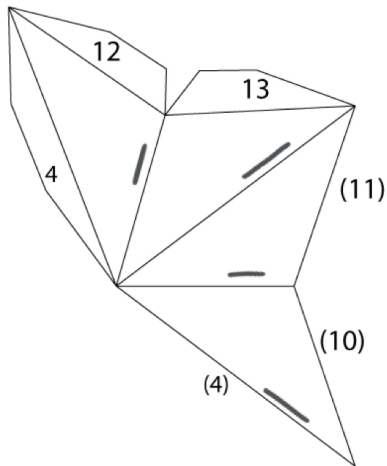
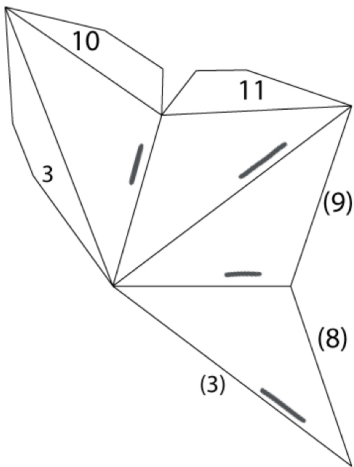
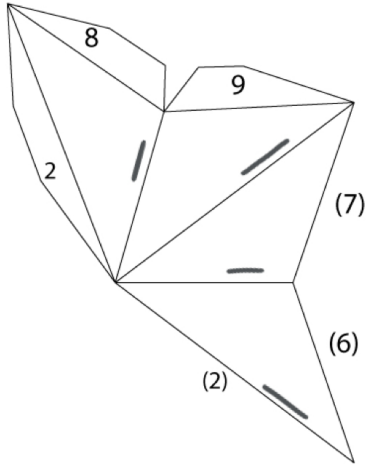
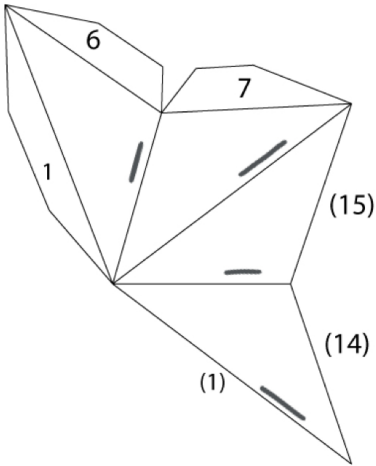

Colour
Suggestion:
yellow

Day 8: Mercury

color : gray

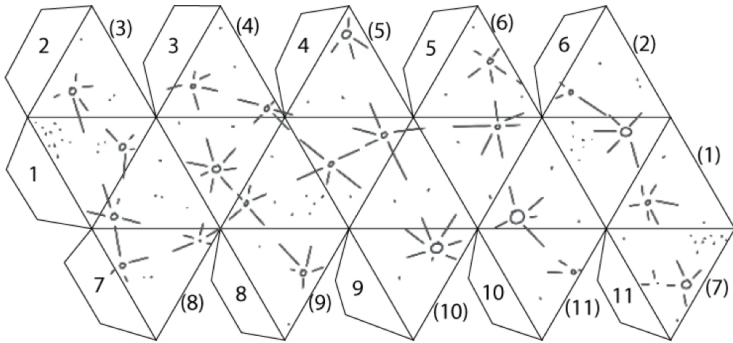

Day 9: Mars

color: Orange

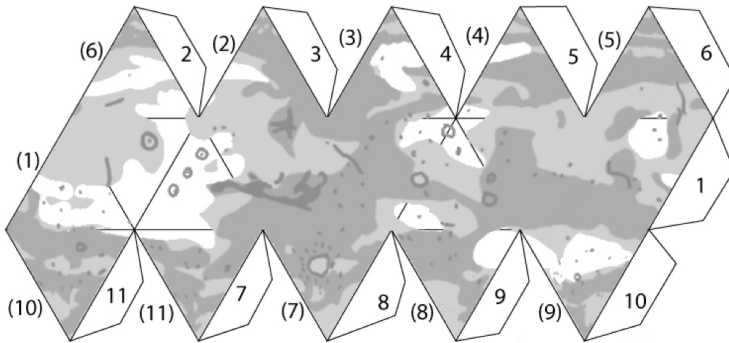

Day 10 : Rocket Spikes

colour : feel free

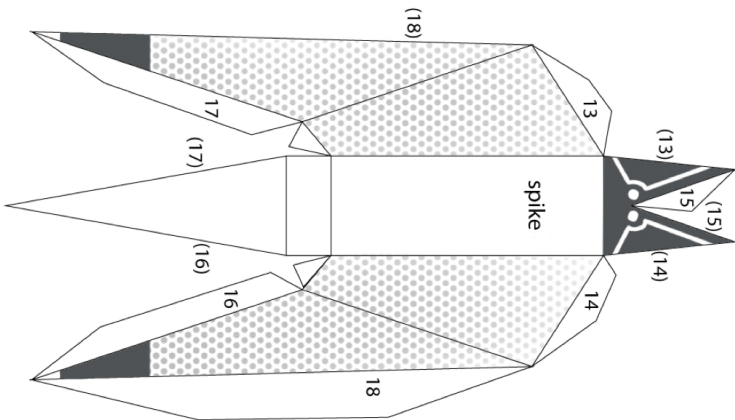
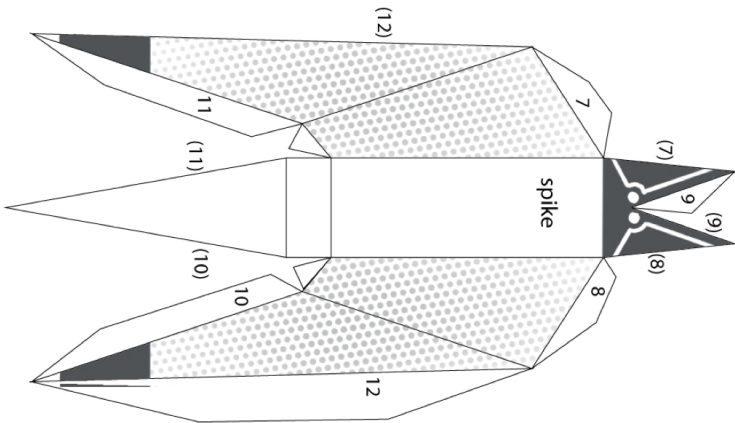
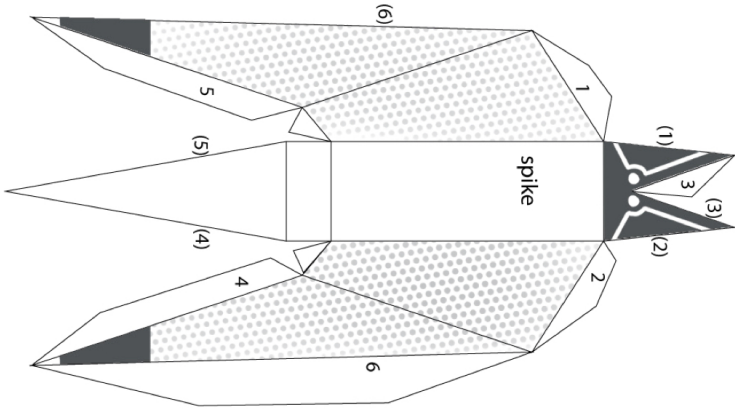

Day 11 : Stars

colour :
yellow

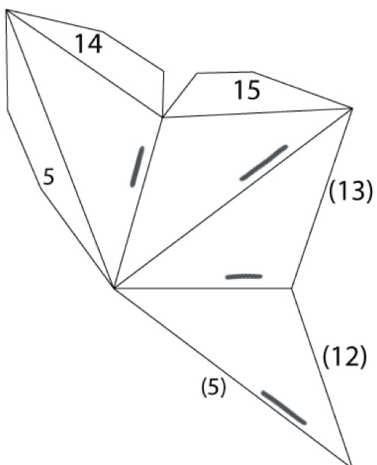
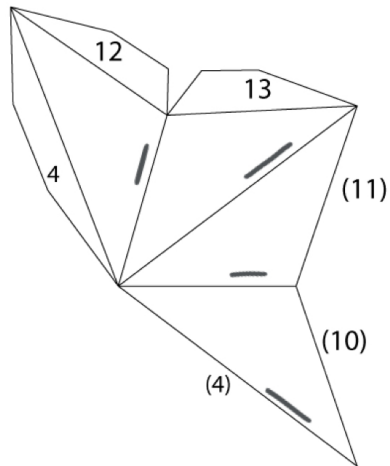
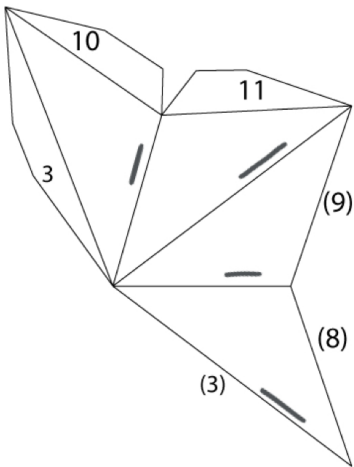
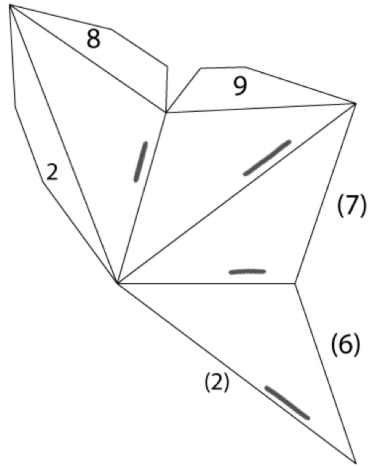
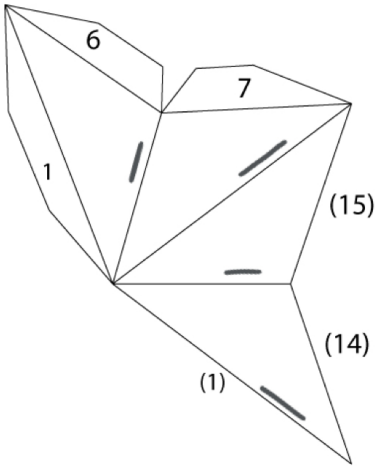

Day 12 : Rocket Door

colour : feel free

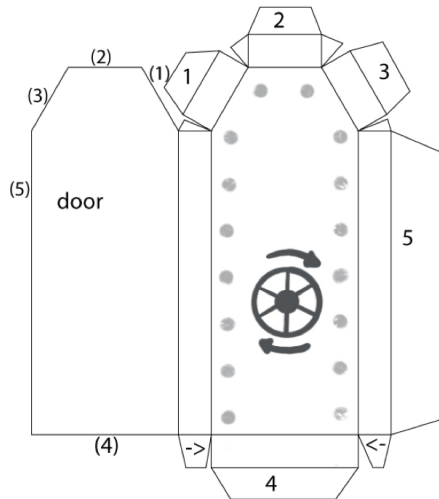

Day 13: Stars

colour:
yellow

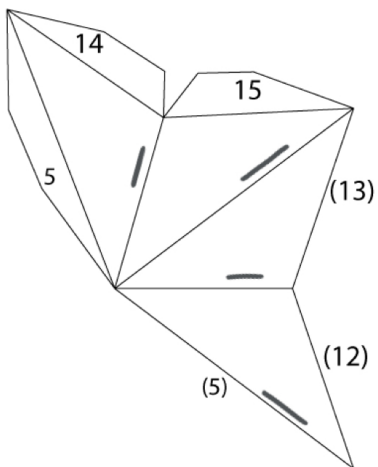
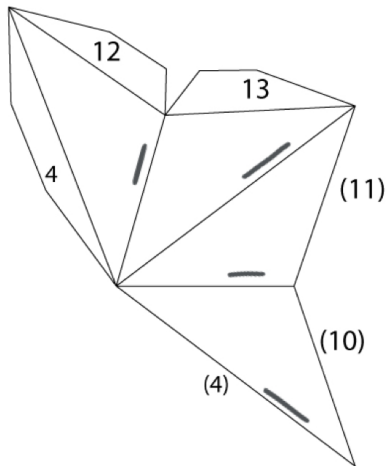
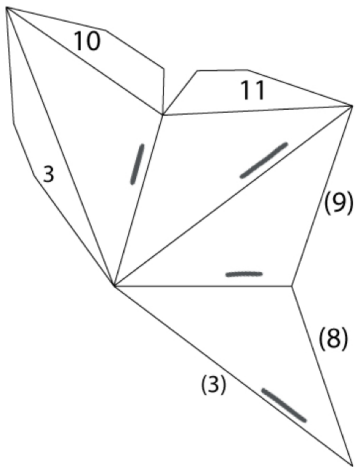
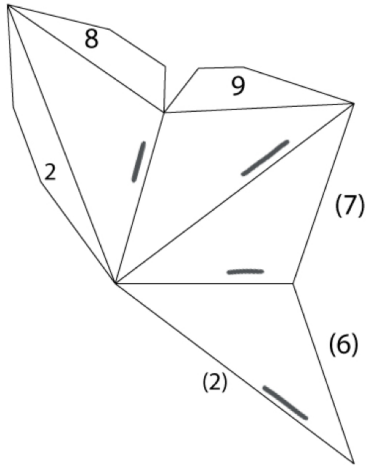
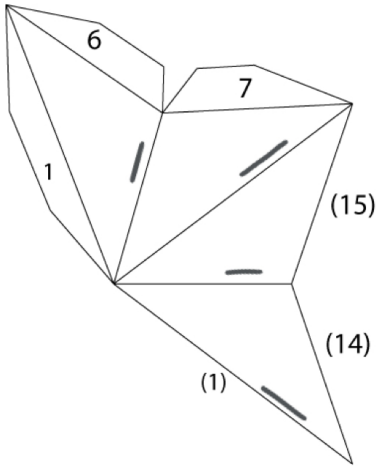

Day 14 : Venus

colour : Beige

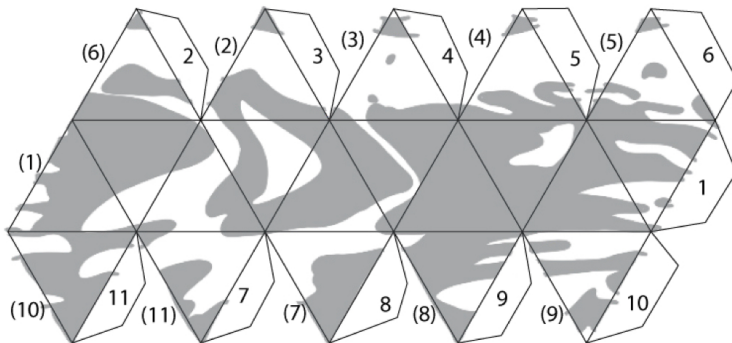

Day 15: Rocket Windows

colour: light Blue

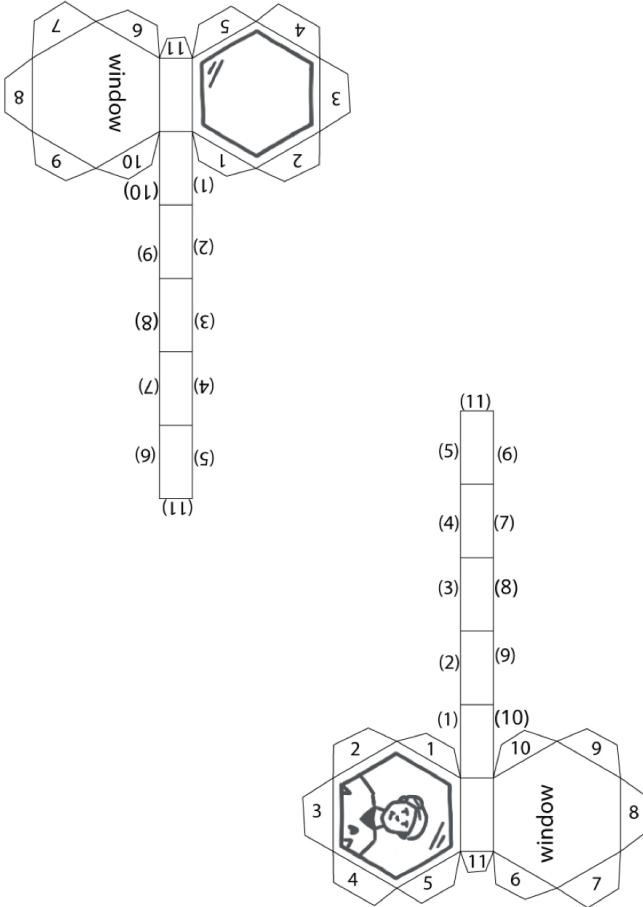

Day 16: Rocket Auspuff

Colour: Dark Gray

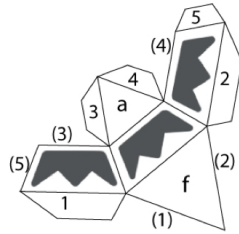
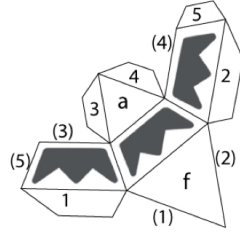
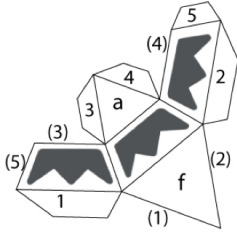

Day 17

Jupiter

colour
orange

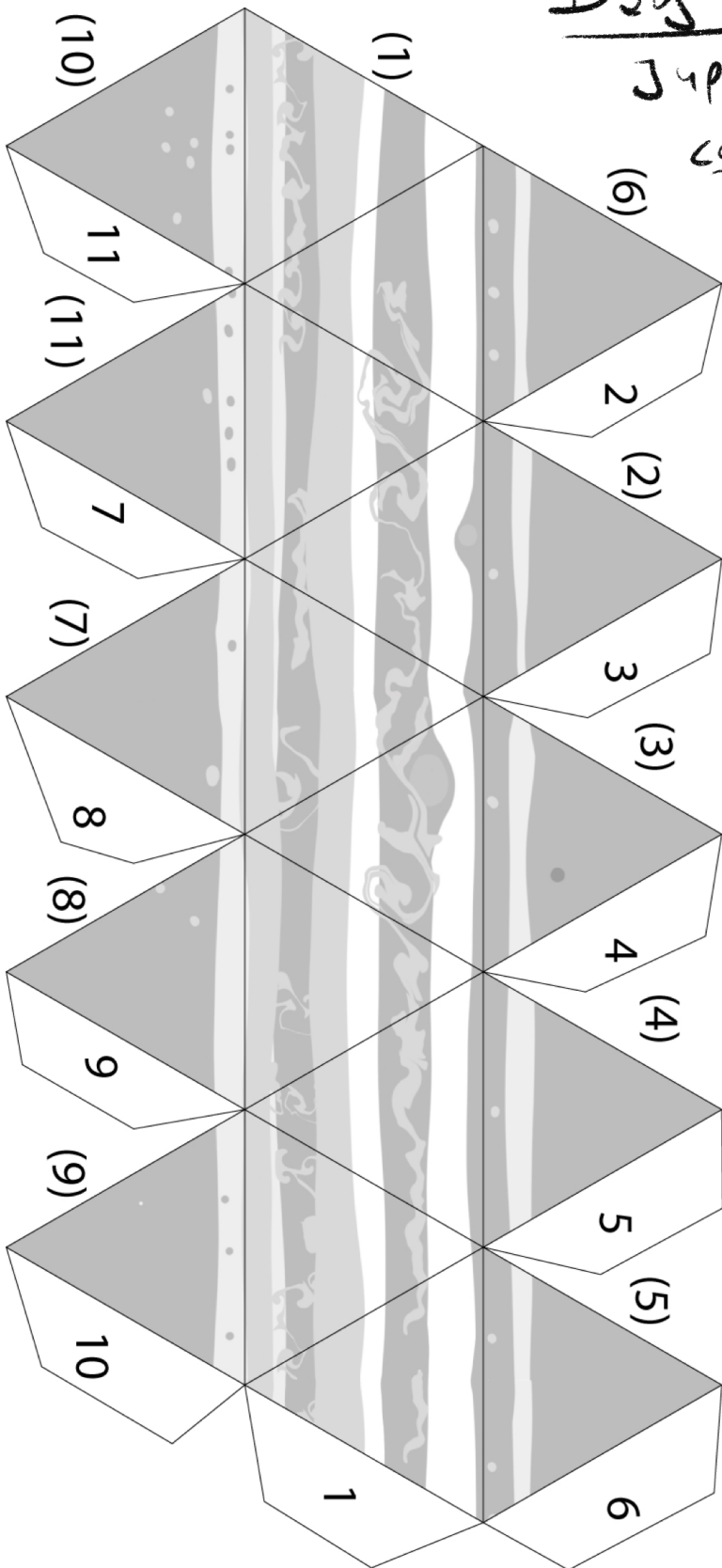

Day 18

Draw
colour:
Blue

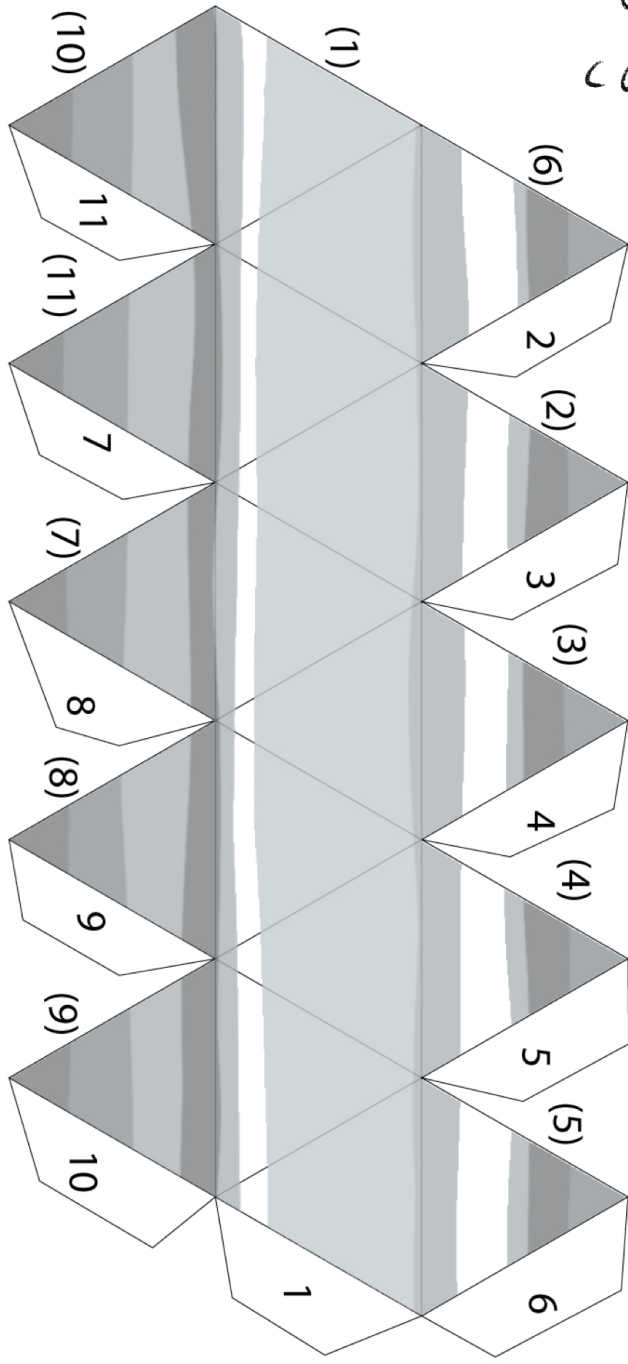

Day 19 UFO Bottom

colour : Dark Green

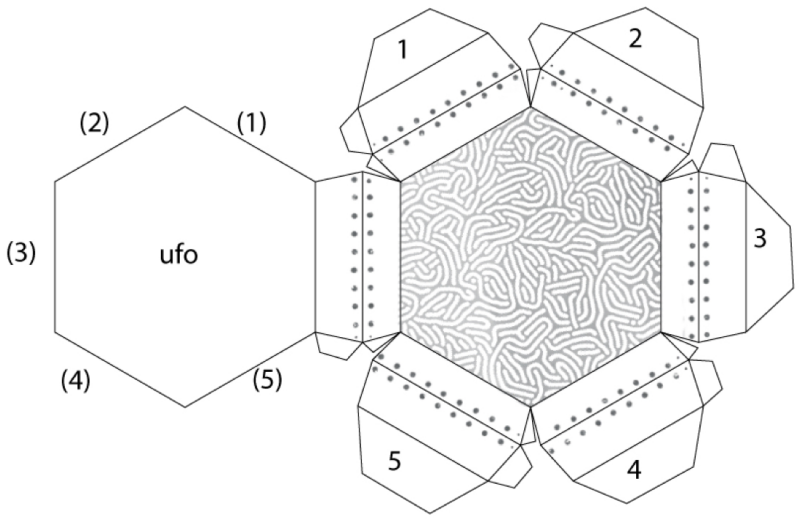

Day 20 : UFO Top

colour: Light Blue

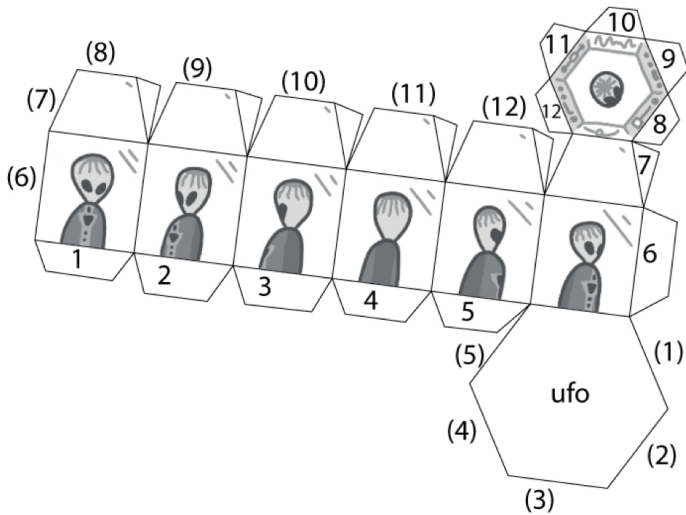

Day 21

Saturn
colour
Beige

part 2

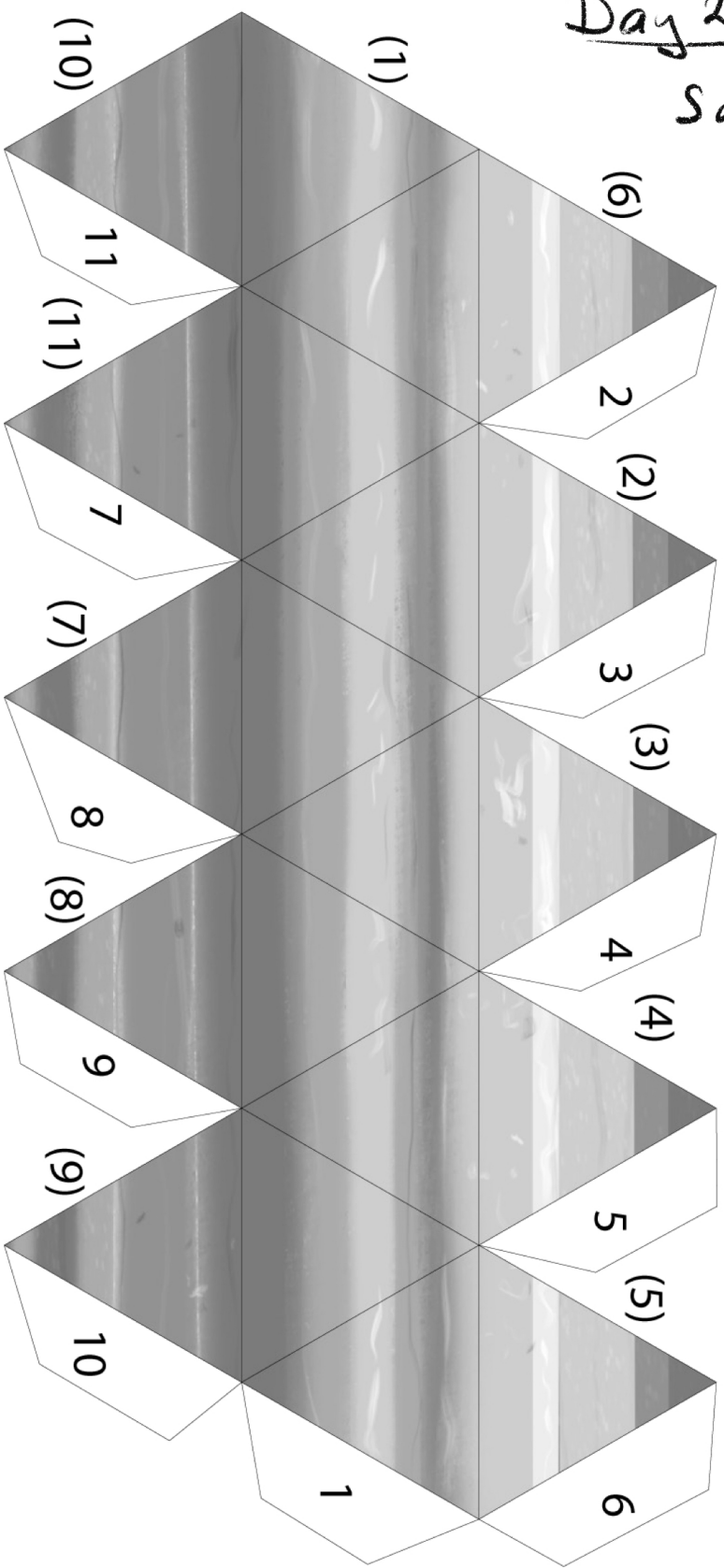

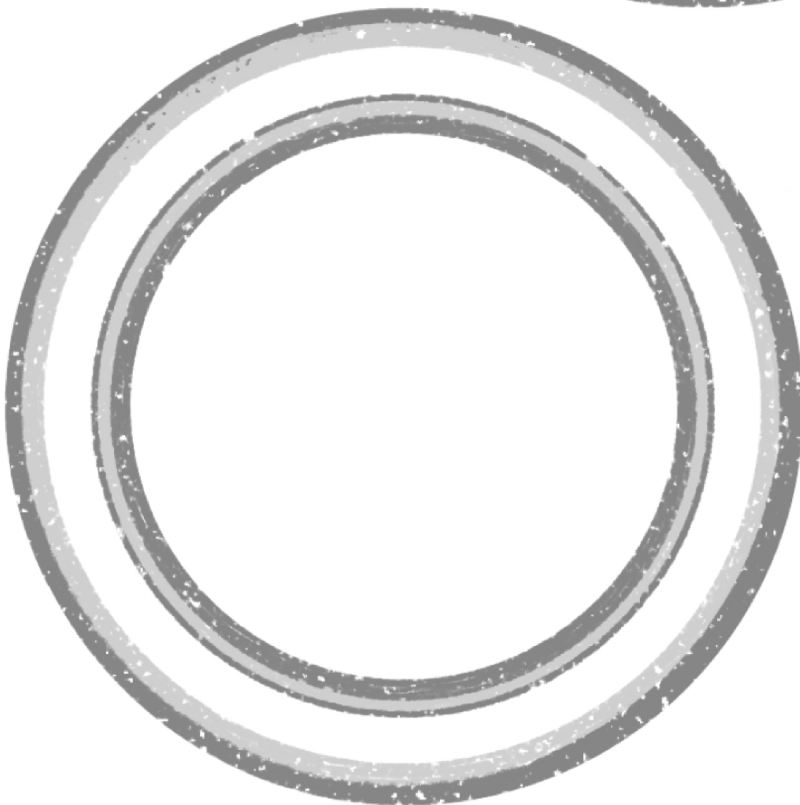
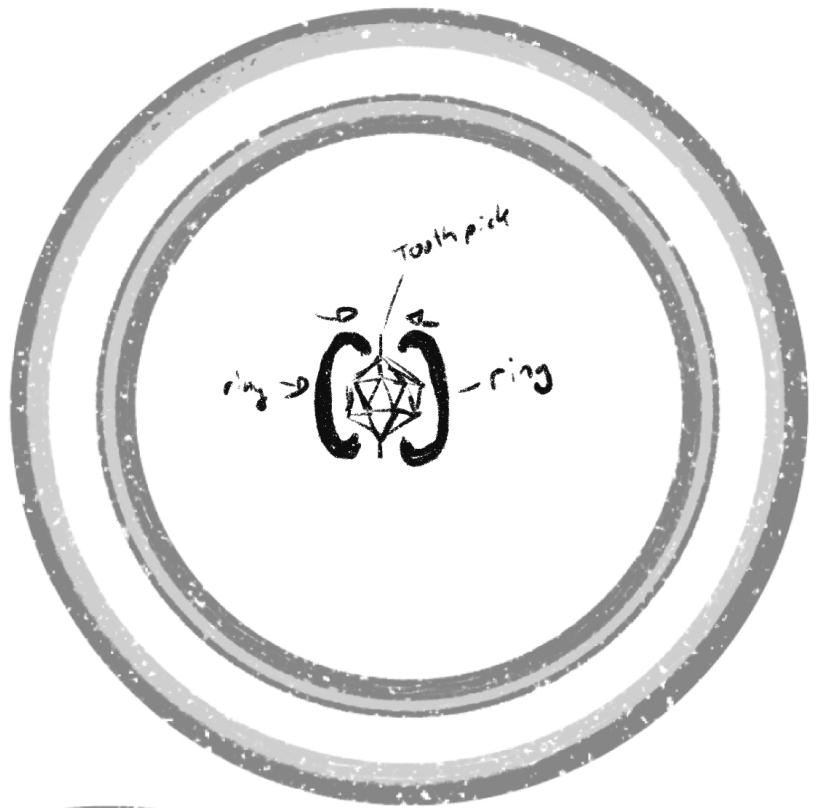

stick
toothpicks
through
planet +
glue the
rings from
both sides
together

Day 22: Rocket Fire

choose either normal or sci-fi fire

normal
(red,
orange,
yellow)

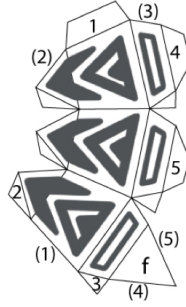
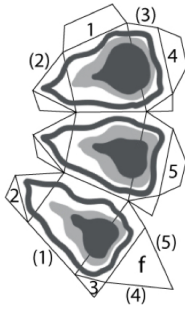

sci-fi
(blue)

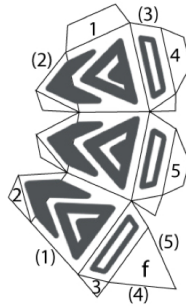
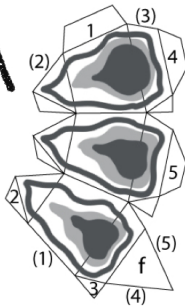
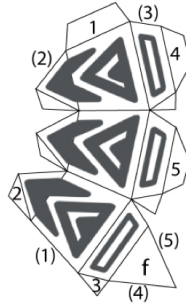
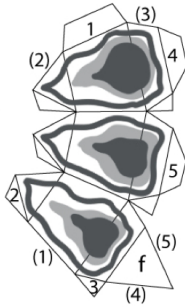

Day 23

Star

colour
yellow

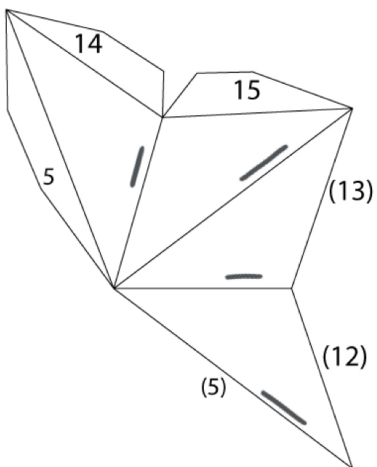
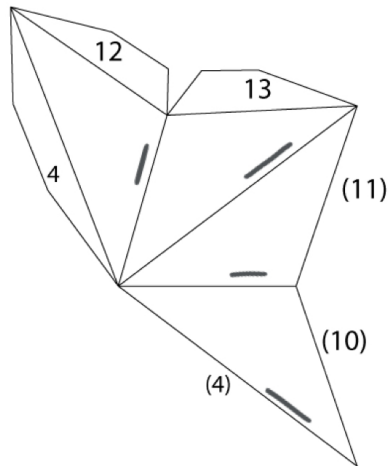
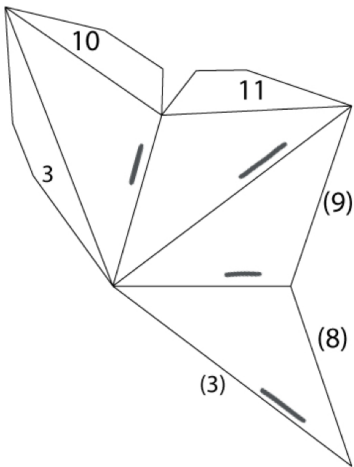
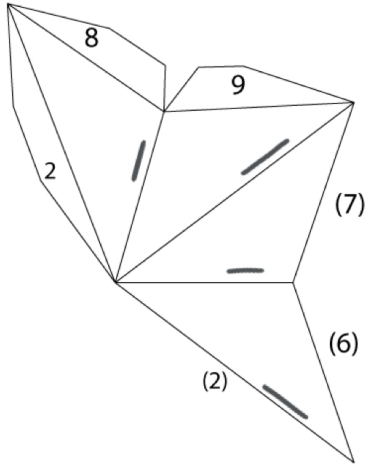
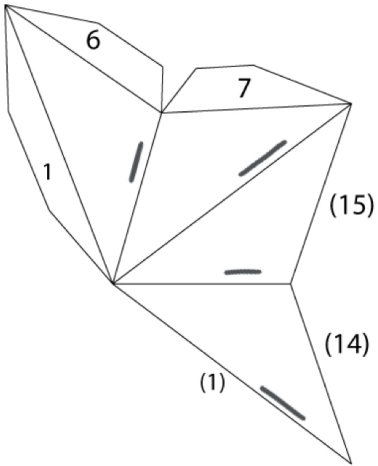

Day 24: The sun

colour: Gold / yellow / orange

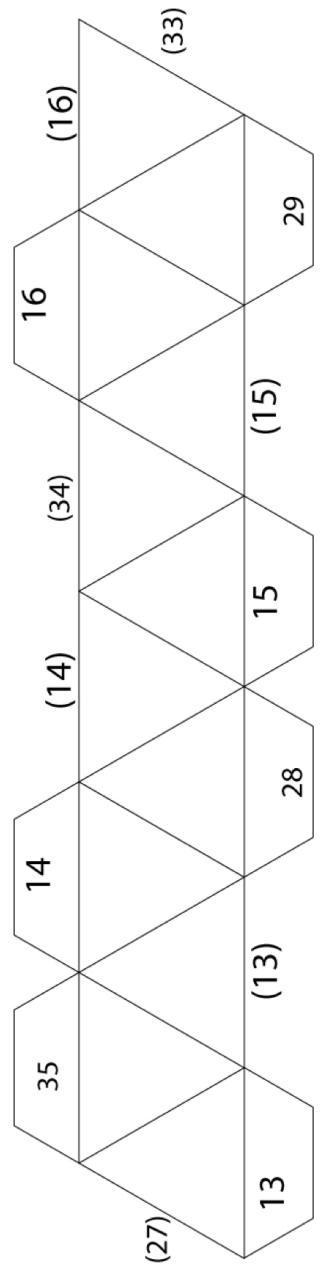
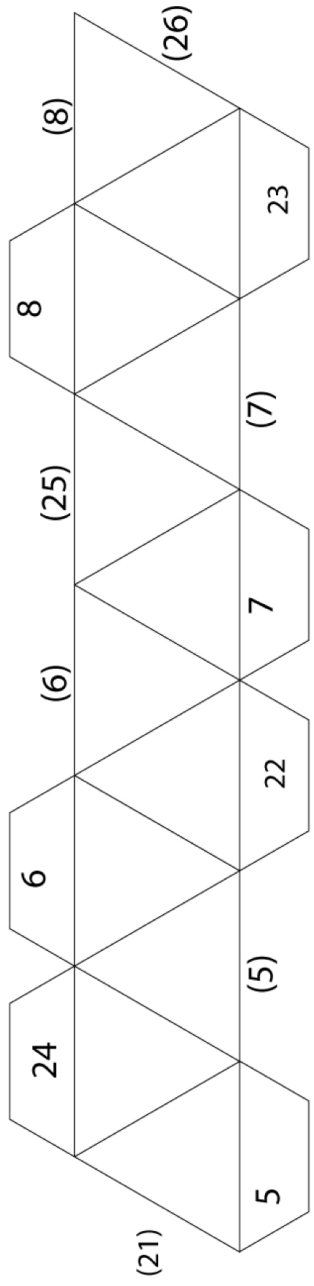
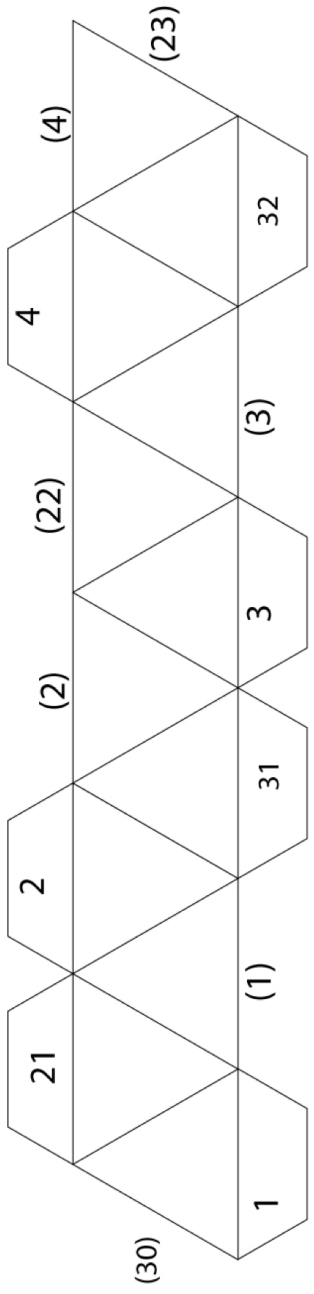

part 2

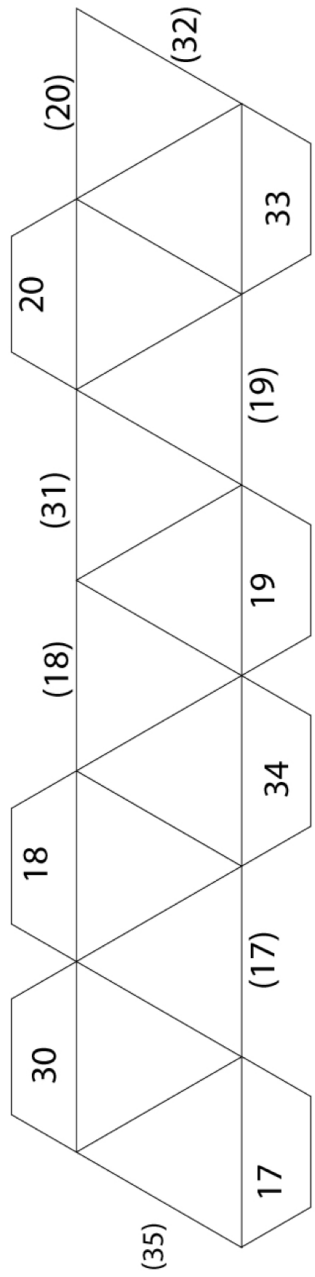
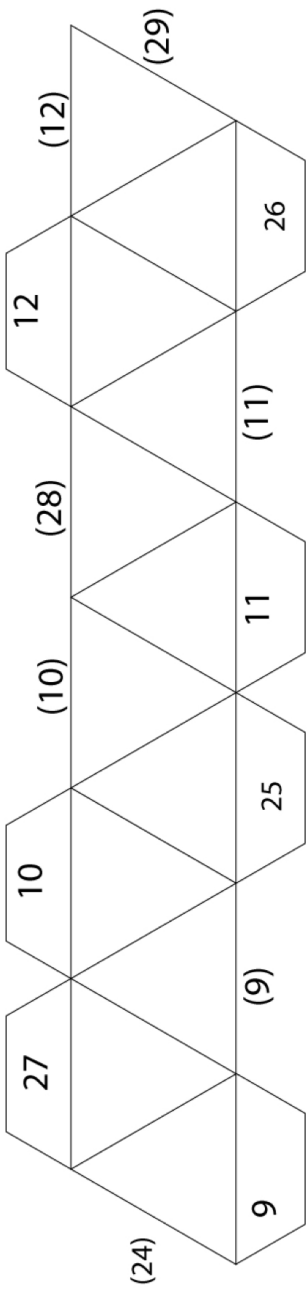

Material needed

⊗ Gluestick

⊗ Scissor

⊗ Pens / Watercolor / Paint

⊗ String & Needle

⊗ 4 Skewers

⊗ 2 Toothpicks

(⊗ White Craft Glue)

(⊗ Washi Tape / Painter's Tape)

Question or need Help?

▷ leo@bourryto.de

▷ @bourryto on Instagram

▷ @bourryto@chaos.social on Mastodon